

Rollform Screen Frame





Mill and paint finishes available

Special colors and sizes available upon request

Please see components for pictures of the corners available

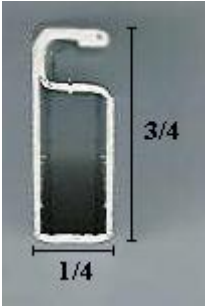
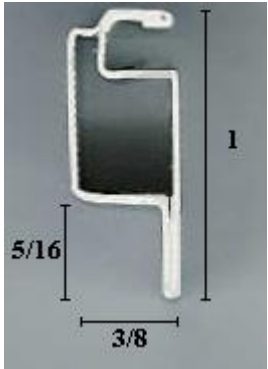
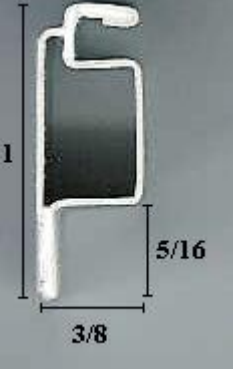
All frames are manufactured to fit .143 spline





		
01-011	01-012	01-015
<p>Corners Available:</p> <p>2-11 SQ</p> <p>2-11 PM</p> <p>2-11 ML</p> <p>2-11 Pull Tab</p> <p>2-11 PS-Stop</p>	<p>Corners Available:</p> <p>2-12</p> <p>2-12PM</p> <p>2-12PW</p>	<p>Corners Available:</p> <p>2-15 SQ</p> <p>2-15 ML</p>

2-11 DCP		
		
01-021	01-038	01-039
<p>Corners Available:</p> <p>2-21ML</p>	<p>Corners Available:</p> <p>2-38SQ</p> <p>2-38 Tab L</p> <p>2-38 Tab R</p>	<p>Corners Available:</p> <p>2-39SQ</p> <p>2-39 Tab R</p> <p>2-39 Tab L</p>
		
01-051	01-056	01-088
<p>Corners Available:</p> <p>2-11SQ</p> <p>2-11PM</p> <p>2-11ML</p> <p>2-11 Pull Tab</p> <p>2-11 PS-Stop</p> <p>2-11 DCP</p>	<p>Corners Available:</p> <p>2-55ML</p> <p>2-55PM</p>	<p>Corners Available:</p> <p>2-88SQ</p> <p>2-88PT</p> <p>2-88ML</p>

Extruded Screen Frame

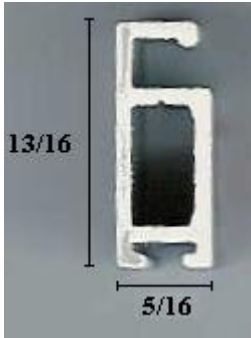
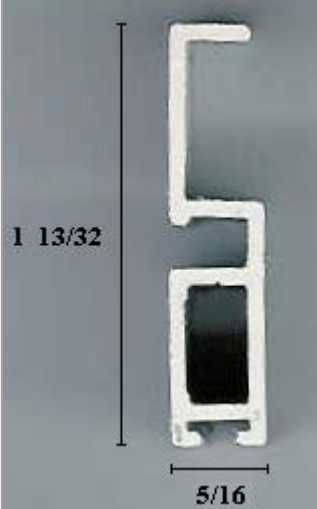
Mill & Paint Finish Available

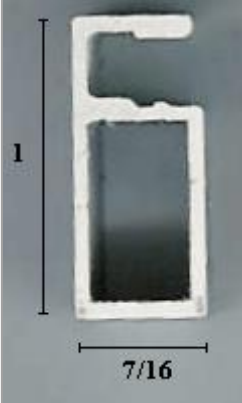
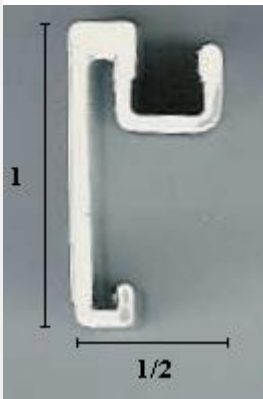
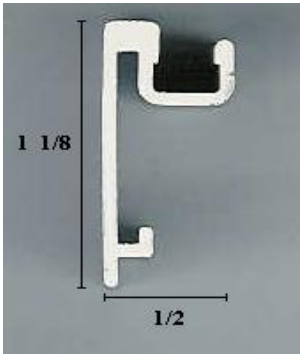
Special colors available upon request

 <p>13/16</p> <p>5/16</p>	 <p>1 13/32</p> <p>5/16</p>	 <p>1</p> <p>5/16</p>	 <p>1</p> <p>7/16</p>
10-065	10-066	10-068	10-069
 <p>1</p> <p>1/2</p>	 <p>1 1/8</p> <p>1/2</p>	 <p>1 1/4</p> <p>1/2</p>	 <p>1 3/8</p> <p>1/2</p>
10-970	10-971	10-973	10-974

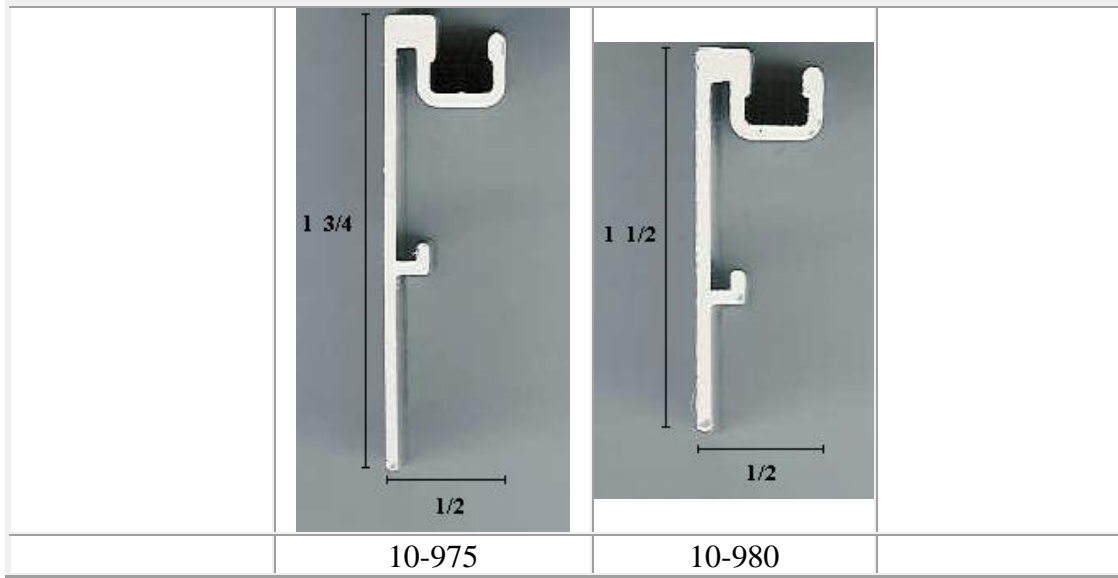

Warning: Insect screens are intended to provide reasonable insect control and are not intended to provide retention of objects or persons within the interior. This screen will not stop a person from falling out of a window or door. Never lean against the screen on an open window or door.

All Products and Information Subject to Change without Notice

All Products May Be Subject to Minimums

All images are not to scale

© COPYRIGHT 2016 ALL RIGHTS RESERVED

Residential Screens



-Single and Double Hung Windows

-Casement Windows

-Awning Windows

-Sliding Windows

-Available in Mill or Painted finishes

-Available in fiberglass, standard bright aluminum or charcoal aluminum wire cloth

-Stainless steel mesh available upon request

Specialty Screens

To your specifications are available. Please contact our office for specific information and drawings.

Commercial Screens

Commercial Screens can be supplied for all institutional and commercial windows including the following styles:

-Single and Double Hung Windows

-Projected and Pivoted Windows

-Push Button Windows

-Casement Windows

-Horizontal Sliding Windows

-Additional Wicket Configurations Available

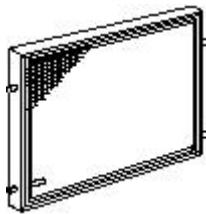

Hopper Screen



Full Height
Hinged Wicket

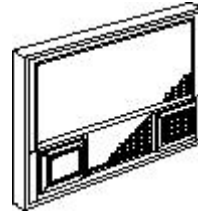

Double Wicket
Screen

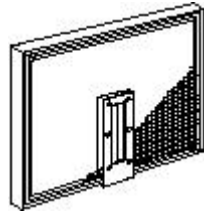

Baffle Screen

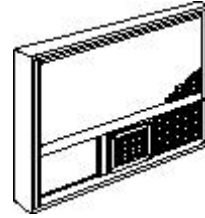

Single Wicket
Screen

Extruded Box Screen Frames

-Construction combines rugged strength and durability of heavy extruded aluminum frames

-Various Materials and finishes

-Frames accept wide variety of finishes including anodizing hard coating or painting

-All models also utilize hardware needed for any specific job

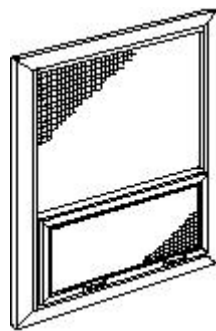

Push Button
Screen

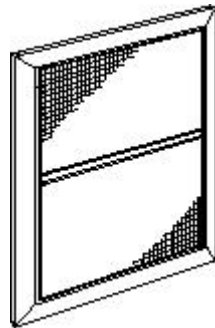

Flat Screen
with Cross
Brace

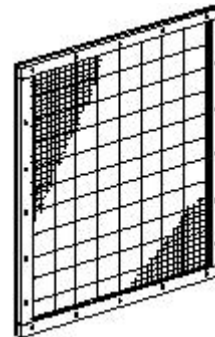

Bird Screen

Warning: Insect screens are intended to provide reasonable insect control and are not intended to provide retention of objects or persons within the interior. This screen will not stop a person from falling out of a window or door. Never lean against the screen on an open window or door.

All Products and Information Subject to Change without Notice

All Products May Be Subject to Minimums

All images are not to scale

© COPYRIGHT 2016 ALL RIGHTS RESERVED

Patio Doors



-Four door styles to meet a variety of needs

-Painted, Anodized or Mill Finish

-Attractively designed with functional engineering to adapt to most door framing conditions

-Doors are reversible for installation and flexibility

-Doors are available with expanders, top hung, with interlock or with materials

-Available in a Knockdown Program

Majestic

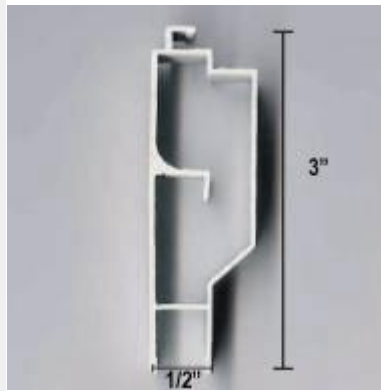

-Architectural Duty

-Miter Corner

Deluxe

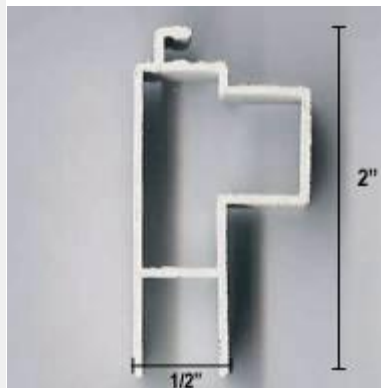

-Heavy Duty

-Miter Corner

REGAL

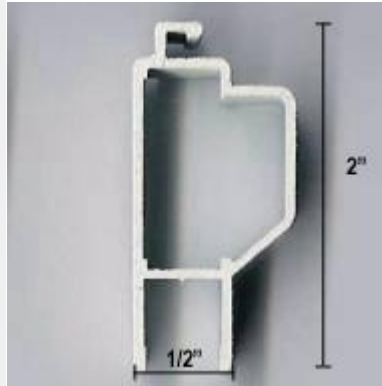

-Heavy Architectural Duty

-Miter Corner

Riviera

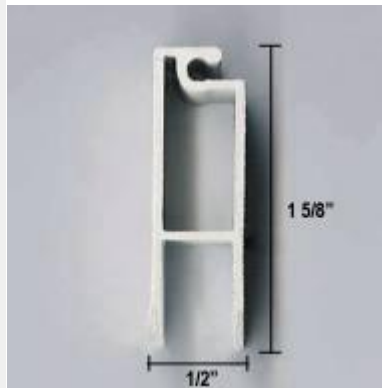

-Medium Duty

-Butt Corner

-Available with Interlock

Amber



Warning: Insect screens are intended to provide reasonable insect control and are not intended to provide retention of objects or persons within the interior. This screen will not stop a person from falling out of a window or door. Never lean against the screen on an open window or door.

All Products and Information Subject to Change without Notice

All Products May Be Subject to Minimums

All images are not to scale

© COPYRIGHT 2016 ALL RIGHTS RESERVED

Glazing Bead

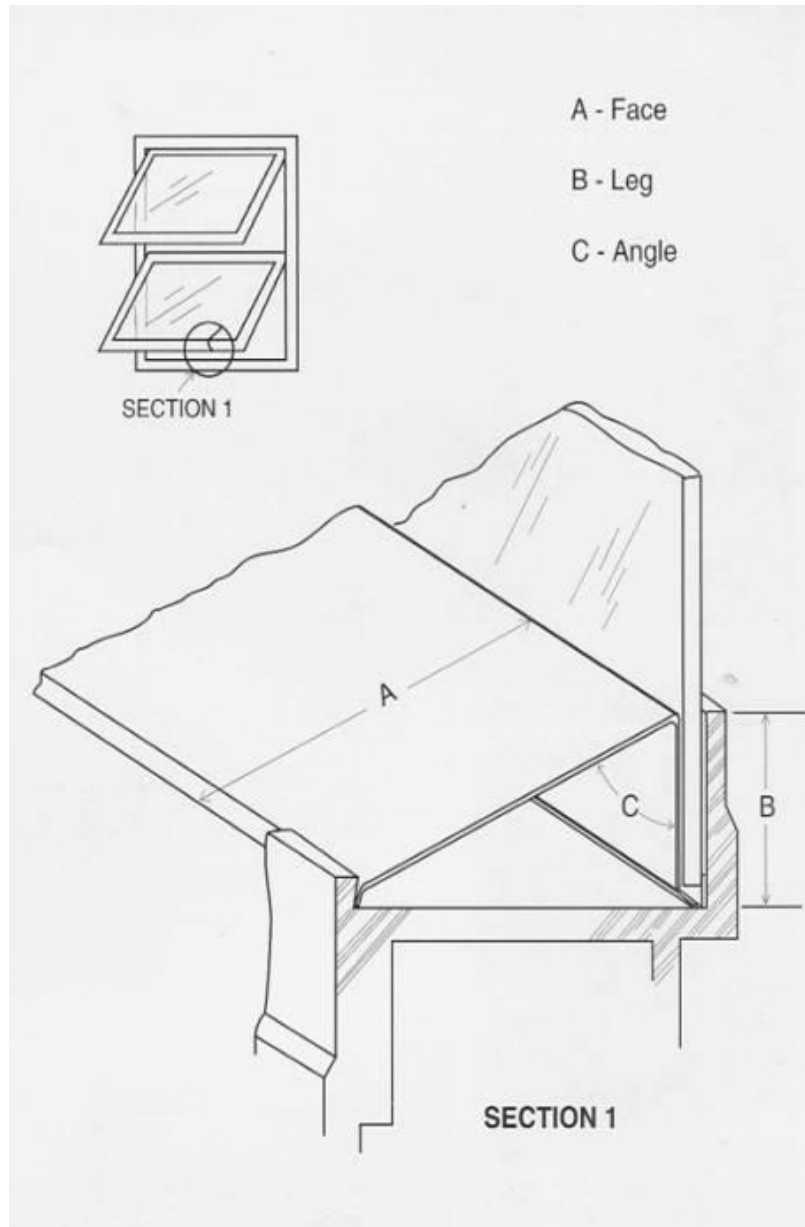

-For All Types of Windows

-Custom Fit to Your Windows

-Lineals or Cut to Size (Miter-Straight)

-Available in Mill, Bronze and White

-Over 200 Shapes Available

-Minimum Quantities May Apply

Warning: Insect screens are intended to provide reasonable insect control and are not intended to provide retention of objects or persons within the interior. This screen will not stop a person from falling out of a window or door. Never lean against the screen on an open window or door.

All Products and Information Subject to Change without Notice

All Products May Be Subject to Minimums

All images are not to scale

© COPYRIGHT 2016 ALL RIGHTS RESERVED

Components

				
02-38WH	02-38P	02-55ML	02-11PM	02-11PS
				
02-55PM	02-11PTWH	02-11WH	115 Corner 02-15BZ	188 Corner 02-88BZ
				
04-013BL	04-014ML	FD4024WH	04-018BL	04-021ML
				
04-022ML	04-058S	04-090	Crossbrace Insert 02-04ML	Stretcher Clip 03-11ML
				

02-05ML	04-001ML	04-005	Ball Head Screw 04-009ML	Friction Hanger 04-015WH
				
Offset Swivel Clip 04-026BL	Wire Loop Latch 04-039ML	04-122ML LH or 04-122ML RH	04-132ML RH or 04-132ML LH	Swivel Clip 04-089
				
Z-Clip Various Sizes	Finger Pull Tab 04-041WH	04-016BZ WH ML	Wire Lift 04-027ML	04-096BL
				
Nylon Pull Tab 04-099BL	Wire Tension Spring 04-007S	Flat Tension Spring 04-035S	No Hole Tension Spring 04-040S	Ramhorn Clip 04-057S
				
04-037P	04-061BL	04-062	04-063BL	04-065BL

				
04-034Z	04-064	06-055BL	06-057BL	Woolpile
				
	M-Roller 09-08LS	Nylon Wheel Roller 09-043C	02-213NPC	

Other components are available. Please contact our office for specifications.

Warning: Insect screens are intended to provide reasonable insect control and are not intended to provide retention of objects or persons within the interior. This screen will not stop a person from falling out of a window or door. Never lean against the screen on an open window or door.

All Products and Information Subject to Change without Notice





All Products May Be Subject to Minimums

All images are not to scale

© COPYRIGHT 2016 ALL RIGHTS RESERVED





Crossbrace, Muntin and Flat Bar

Crossbrace

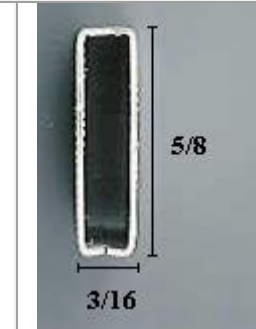
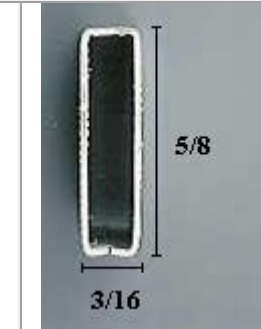
			
01-004	01-007	01-008 Lockseam	01-009

Muntin

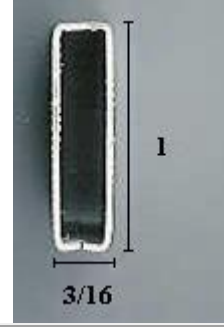
		
01-1316555	01-1316610	01-1316625

		
01-136770	01-1316805	01-1316100
		
01-825	01-825J	

Flatbar

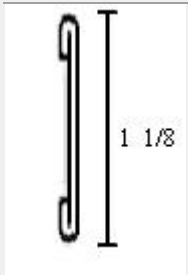
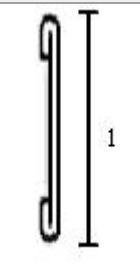
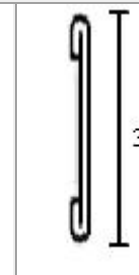
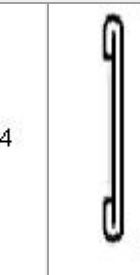
			
01-205	01-206	01-207	01-208

Pyramid

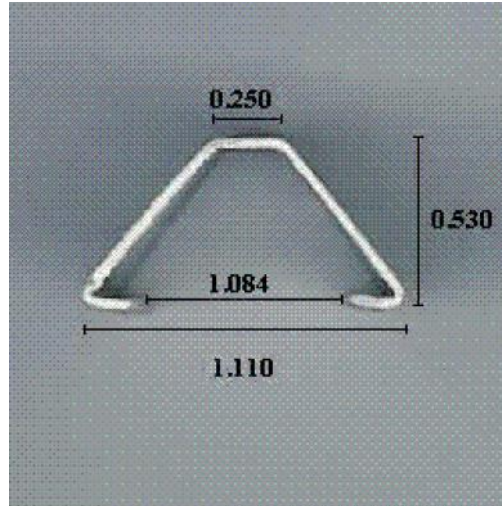

Warning: Insect screens are intended to provide reasonable insect control and are not intended to provide retention of objects or persons within the interior. This screen will not stop a person from falling out of a window or door. Never lean against the screen on an open window or door.

All Products and Information Subject to Change without Notice

All Products May Be Subject to Minimums

All images are not to scale

© COPYRIGHT 2016 ALL RIGHTS RESERVED